

Monodraught

Natural Ventilation using Windcatchers





- Dr Naghman Khan
- Naghman.khan@monodraught.com
- Naghman.khan@nottingham.ac.uk

CIBSE BSG Seminar: Natural and Mixed-Mode Ventilation Modelling

Natural Ventilation using Windcatchers

- **OUTLINE:**
 1. The use of Windcatchers
 2. Current research on Windcatchers
 3. Integration into dynamic thermal modelling
 4. Simple advice on how to model Windcatchers

CIBSE BSG Seminar: Natural and Mixed-Mode Ventilation Modelling

Natural Ventilation using Windcatchers

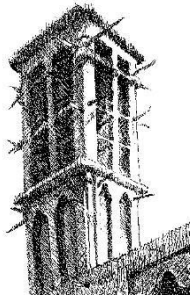
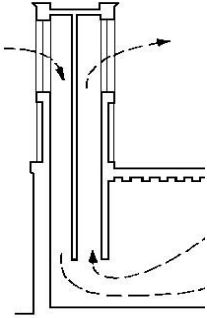
CIBSE BSG Seminar: Natural and Mixed-Mode Ventilation Modelling

Natural Ventilation using Windcatchers



CIBSE BSG Seminar: Natural and Mixed-Mode Ventilation Modelling

Natural Ventilation using Windcatchers







CIBSE BSG Seminar: Natural and Mixed-Mode Ventilation Modelling

Natural Ventilation using Windcatchers



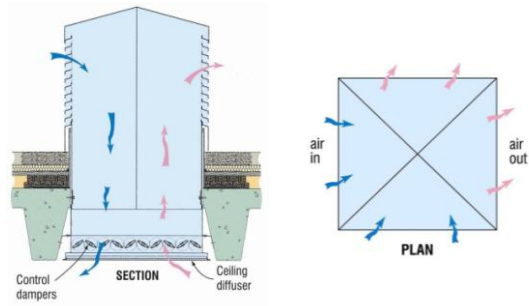

CIBSE BSG Seminar: Natural and Mixed-Mode Ventilation Modelling

Natural Ventilation using Windcatchers

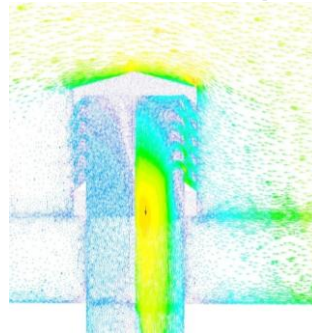

CIBSE BSG Seminar: Natural and Mixed-Mode Ventilation Modelling

Natural Ventilation using Windcatchers



CIBSE BSG Seminar: Natural and Mixed-Mode Ventilation Modelling

Natural Ventilation using Windcatchers

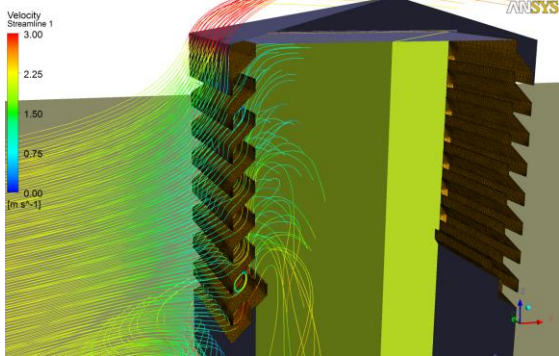

CIBSE BSG Seminar: Natural and Mixed-Mode Ventilation Modelling

Natural Ventilation using Windcatchers

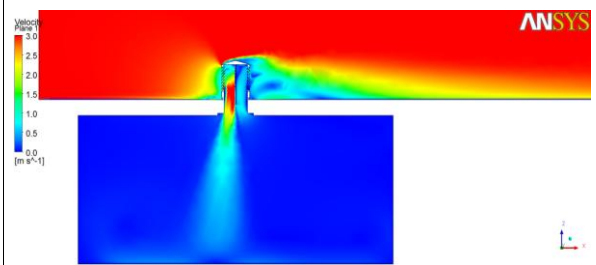

CIBSE BSG Seminar: Natural and Mixed-Mode Ventilation Modelling

Natural Ventilation using Windcatchers

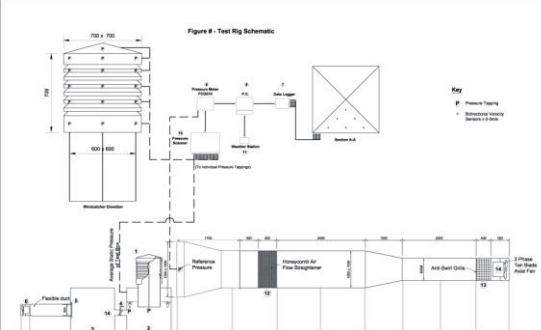

Natural Ventilation using Windcatchers



CIBSE BSG Seminar: Natural and Mixed-Mode Ventilation Modelling

Natural Ventilation using Windcatchers



CIBSE BSG Seminar: Natural and Mixed-Mode Ventilation Modelling

Natural Ventilation using Windcatchers

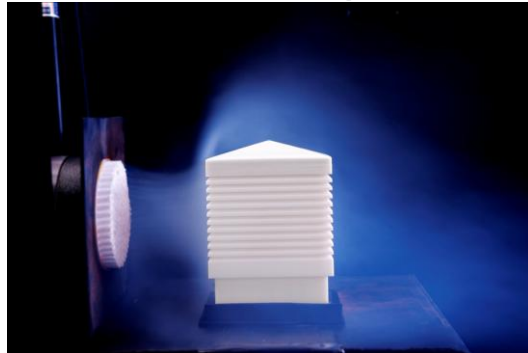

CIBSE BSG Seminar: Natural and Mixed-Mode Ventilation Modelling

Natural Ventilation using Windcatchers



CIBSE BSG Seminar: Natural and Mixed-Mode Ventilation Modelling

Natural Ventilation using Windcatchers



CIBSE BSG Seminar: Natural and Mixed-Mode Ventilation Modelling

Natural Ventilation using Windcatchers



CIBSE BSG Seminar: Natural and Mixed-Mode Ventilation Modelling

Natural Ventilation using Windcatchers

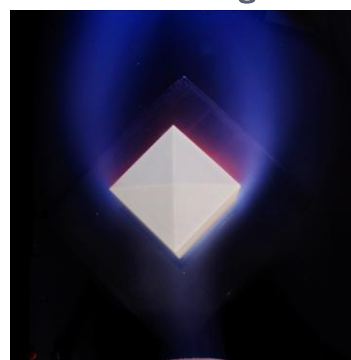

CIBSE BSG Seminar: Natural and Mixed-Mode Ventilation Modelling

Natural Ventilation using Windcatchers



CIBSE BSG Seminar: Natural and Mixed-Mode Ventilation Modelling

Natural Ventilation using Windcatchers



CIBSE BSG Seminar: Natural and Mixed-Mode Ventilation Modelling

Natural Ventilation using Windcatchers

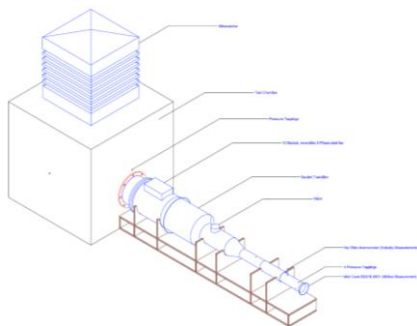

CIBSE BSG Seminar: Natural and Mixed-Mode Ventilation Modelling

Natural Ventilation using Windcatchers



CIBSE BSG Seminar: Natural and Mixed-Mode Ventilation Modelling

Natural Ventilation using Windcatchers

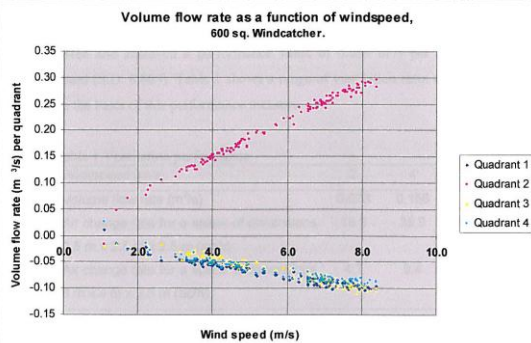

CIBSE BSG Seminar: Natural and Mixed-Mode Ventilation Modelling

Natural Ventilation using Windcatchers

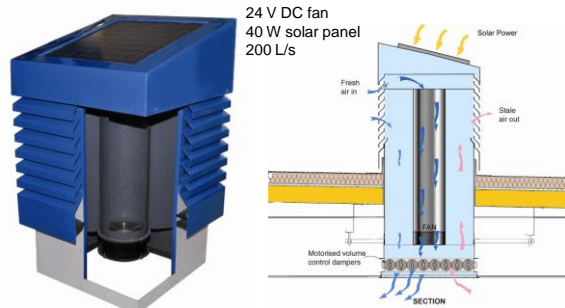

CIBSE BSG Seminar: Natural and Mixed-Mode Ventilation Modelling

Natural Ventilation using Windcatchers

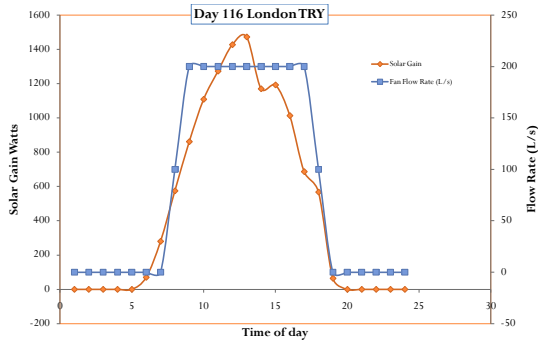

CIBSE BSG Seminar: Natural and Mixed-Mode Ventilation Modelling

Natural Ventilation using Windcatchers

Key factors influencing performance:

- Size and shape
- Pressure flow characteristics - Coefficient of Discharge
- Wind speed, direction and local pressure coefficients
- Buoyancy and temperature differences
- Location on building
- Orientation and location of building and surrounding terrain type
- Other openings
- Intended use
- User control

CIBSE BSG Seminar: Natural and Mixed-Mode Ventilation Modelling

Natural Ventilation using Windcatchers

Key Benefits:

- Wind and buoyancy driven ventilation
- Volume control via Temperature, CO2
- Very low energy consumption (4W motor on dampers)
- Supply and extract ventilation
- Fresh air supplied from high level – less pollution
- Works well with many different ventilation strategies
- Night time ventilation
- Solar powered mixed mode to prevent overheating
- Acoustic lining, many shapes and sizes
- Need to be accurately modelled...

CIBSE BSG Seminar: Natural and Mixed-Mode Ventilation Modelling

Natural Ventilation using Windcatchers

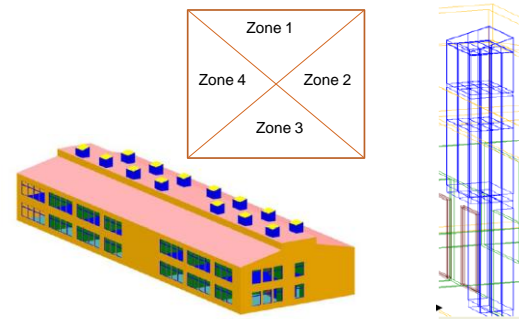

CIBSE BSG Seminar: Natural and Mixed-Mode Ventilation Modelling

Natural Ventilation using Windcatchers

	ΔT	Peak Temp °C	Hours above 28°C
WC+SB Only			
Ground Floor	3.07	31.97	11
First floor	3.32	32.14	16
WC+SB+ night ventilation			
Ground Floor	2.67	31.85	11
First Floor	2.88	31.92	13

CIBSE BSG Seminar: Natural and Mixed-Mode Ventilation Modelling

Natural Ventilation using Windcatchers

1. Draw the model as close to exact dimensions (Areas, volumes)
2. Remove floors/ceilings where appropriate
3. Zone each quadrant separately
4. Add PV panel if using mixed mode system
 1. Calculate flow rates from incident solar radiation
 2. Apply additional flow rates as IZAM/Vent from outside
5. Apply aperture opening types / effective areas / Cd

CIBSE BSG Seminar: Natural and Mixed-Mode Ventilation Modelling

Natural Ventilation using Windcatchers

What is the Discharge Coefficient?

- Non dimensional number which describes the flow behaviour of an opening
- Is dependent on the geometry and Reynolds number of the flow
- Takes into account the contraction and friction of flow through opening
- Is a very dynamic quantity

$$Q = C_d A \sqrt{2 \Delta p / \rho} \quad Q = C_d A \sqrt{gH \frac{\Delta T}{T_i}}$$

CIBSE BSG Seminar: Natural and Mixed-Mode Ventilation Modelling

Natural Ventilation using Windcatchers

Where to get accurate values for the discharge coefficient?

- A known flow rate is passed through the system and ΔP is recorded
- Two way flow
- Damper and diffusers also tested
- Repeated several times
- For various opening areas

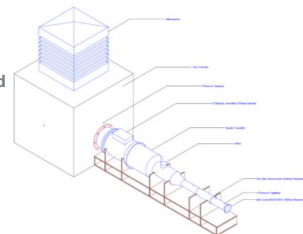

CIBSE BSG Seminar: Natural and Mixed-Mode Ventilation Modelling

Natural Ventilation using Windcatchers

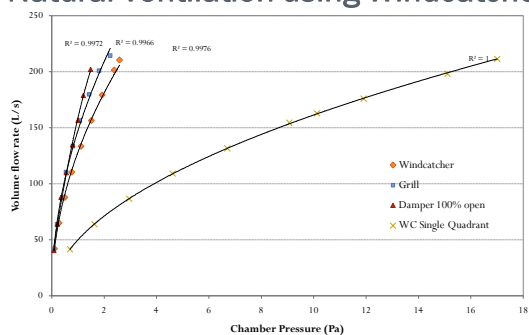

CIBSE BSG Seminar: Natural and Mixed-Mode Ventilation Modelling

Natural Ventilation using Windcatchers

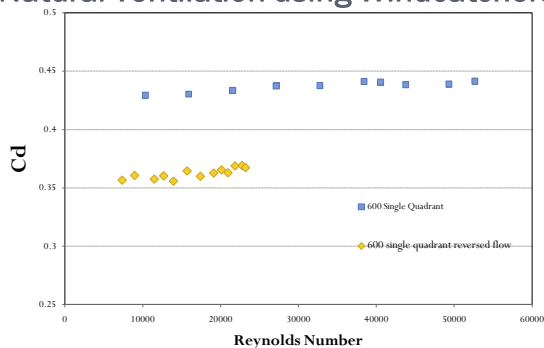

CIBSE BSG Seminar: Natural and Mixed-Mode Ventilation Modelling

Natural Ventilation using Windcatchers

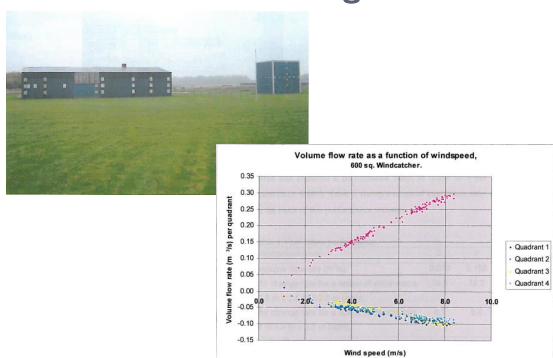

CIBSE BSG Seminar: Natural and Mixed-Mode Ventilation Modelling

Natural Ventilation using Windcatchers

- Same system modelled as was tested in the wind tunnel and Cd tests
- Room dimensions, constructions and materials as actual building
- Unoccupied, modest heat gains, infiltration added
- Using bespoke weather file to represent field monitoring conditions
- Various Cd values used
- Bespoke wind pressure coefficient file used
- Only leeward Cp varied significantly

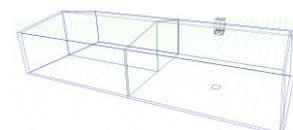

CIBSE BSG Seminar: Natural and Mixed-Mode Ventilation Modelling

Natural Ventilation using Windcatchers



CIBSE BSG Seminar: Natural and Mixed-Mode Ventilation Modelling

Natural Ventilation using Windcatchers

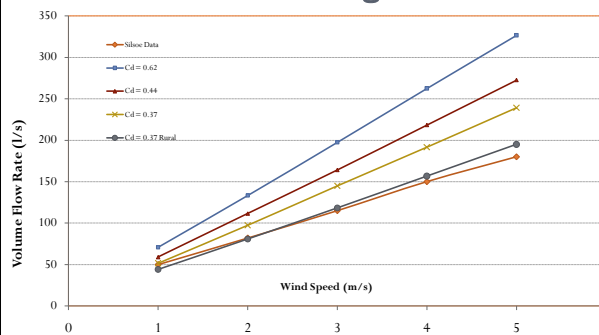

CIBSE BSG Seminar: Natural and Mixed-Mode Ventilation Modelling

Natural Ventilation using Windcatchers

Findings:

- Discharge coefficient had the primary affect in influencing Wind catcher performance
- Accurate values are essential for product representation
- Cd values must come from a trusted source to give users confidence in the results (Sales vs Integrity)
- Burden on manufacturers to provide this data to the building simulation users community
- Further research is looking at larger systems under buoyancy driven flows / model scale testing / insulation

CIBSE BSG Seminar: Natural and Mixed-Mode Ventilation Modelling

Natural Ventilation using Windcatchers

Acknowledgements:



Department of Architecture and the Built Environment
www.nottingham.ac.uk/sbe



www.monodraught.com

CIBSE BSG Seminar: Natural and Mixed-Mode Ventilation Modelling